

Adhesive bonding technology

Manufacturing technology

From the first idea to
the final practical solution



Fraunhofer Institut
Fertigungstechnik
Materialforschung

Content

Customized rather than standard solutions	1
The aim is an optimum production process	3
Proposals that are technically and economically viable	4
Ideal implementation – from experiment to series production	5

Fraunhofer-Gesellschaft (FhG) Research partner for industry

The Fraunhofer-Gesellschaft is the leading organization for institutes of applied research in Europe. It currently operates 58 research institutes and employs about 12,700 people at various locations throughout Germany. Most of the annual research budget of about 1 billion euros is directed at contract research for both private industry and public sector. The results of this research make a key contribution of safeguarding the position of industry in Germany.

IFAM

Expertise and know-how – Adhesive Bonding Technology and Surfaces –

The Fraunhofer Institute for Manufacturing Technology and Applied Materials Research – Adhesive Bonding Technology and Surfaces (IFAM) is the largest independent research organization in Europe in the area of industrial bonding technology. More than 100 employees are actively engaged in research and development work, with their goal being to develop application-orientated bonding system solutions for industry. Multifunctional products, lightweight construction and miniaturization – realized by intelligent combination of materials – offer new opportunities and IFAM has the know-how to bring these to fruition. The work of the institute extends from fundamental research through to manufacturing and on to the market introduction of new products. Industrial fields of application are in plant engineering, vehicle manufacture and micro-assembly and in the packaging, textile and electronics industries.

The business field Adhesive Bonding Technology is principally concerned with the development and characterization of adhesives, with the constructional design of adhesive bonds and with their realization and qualification. Another key area of work is the provision of certified training courses and follow-up courses in the area of bonding technology. This is so because appropriate, timely and competent staff training is becoming ever more important for technology transfer. The business field Surfaces is divided into plasma technology and coatings technology. These areas are concerned with the pretreatment of the surfaces of the materials which are used. As a result, additional properties are conferred on the materials which enables them to be used in other areas of application. A field being worked in by both areas is Surface and Interfacial Analysis. The fundamental knowledge being obtained here guarantees the reliability of adhesive bonds and coatings.

← Figures on title page:

(left)
Section: Robot

(middle)
Section: Simulation

(right)
Precision dosing unit

Customized rather than standard solutions

When integrating bonding technology into a manufacturing process, an optimum result is only achieved if all parts of the total system are harmonized with each other to the best possible degree. This is a service that IFAM offers to its customers.

When two components are to be joined using adhesive, an adhesive processing chain of the highest quality is required. Interdisciplinary work allows the IFAM specialists in the manufacturing technology business field to join the different sub-systems of the process together in a seamless way. This varied expertise includes knowledge of the chemical and physical processes right through to selection of plant components and the design of the manufacturing process.

From the first idea right through to realization

The key technology of bonding can now be counted amongst other established joining techniques such as riveting, welding and soldering. In almost all sectors of industry, the intelligent use of bonding technology allows new products to be made and considerable costs to be saved. IFAM is Europe's largest independent research institute in this field and possesses the expertise that is required for implementing bonding technology in a broad range of industrial processes. In the manufacturing technology business field, optimized solutions tailored to customers' individual requirements are being developed for trouble-free integration of this joining technique into production processes.

With regard to the implementation of bonding technology in a manufacturing environment, the manufacturing technology business field at IFAM supports customers from the conception of the first idea right through to final implementation in series production. In contrast to conventional joining techniques, the use of bonding requires considerations to be made at an early stage about the sequence and design of the manufacturing process. By carefully considering the relevant boundary conditions, optimum use can be made of the diverse expertise and knowledge at IFAM. This leads to an optimized rather than a standard solution, namely a solution that meets the specific requirements of the customer. Close integration of simulation and planning results in ideal integration of bonding into the manufacturing process. Constant input from the individual work groups at IFAM – perhaps regarding the processing properties of an adhesive or the surface modification of the components being joined – guarantees a technologically sound solution. IFAM naturally has extensive experience of combining bonding technology with mechanical joining techniques.

(top) Micro-assembly workplace at IFAM.

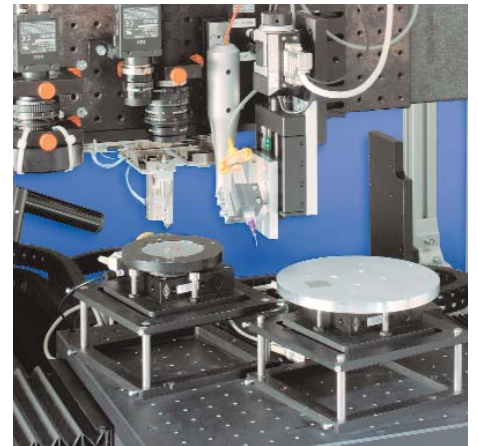

(middle and bottom) Hybrid joining of steel and aluminium.

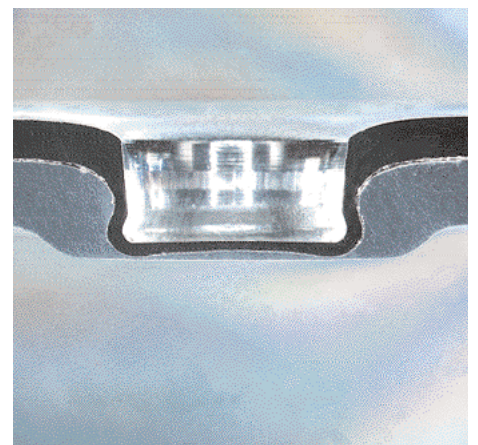
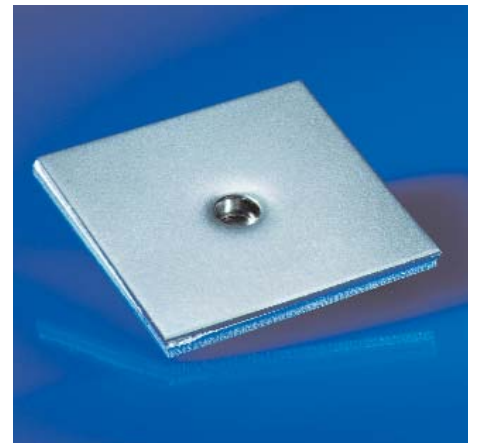

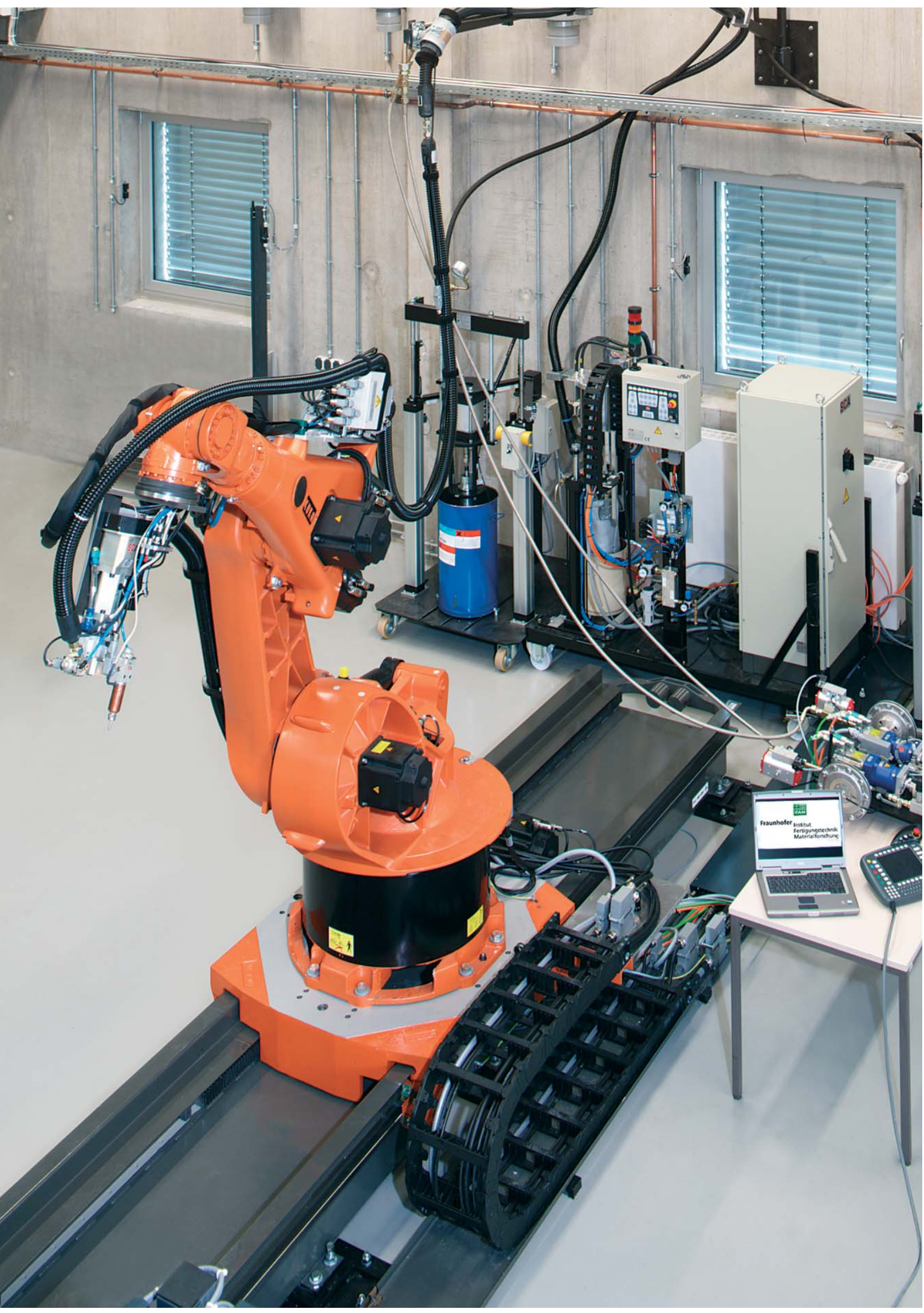

The aim is an optimum production process

The Fraunhofer IFAM has a wealth of specialized knowledge in all aspects of bonding technology that contributes to the results of the manufacturing technology business field. Two examples of this specialist knowledge are given here: IFAM scientists have expert knowledge of the formulation and characterization of adhesives because the composition of an adhesive has a major effect on its flow and processing properties. Suitable modification of the surfaces of the components being joined is also in some cases important for successful bonding – IFAM also possesses specialist knowledge of this area.

The manufacturing technology business field at IFAM does not provide standard solutions – it develops customized solutions to meet individual requirements. This philosophy applies not just where bonding alone is used as the joining technique but also where bonding is used in conjunction with other joining methods.

Interdisciplinary expertise

The key for successful application of bonding technology in an industrial process is timely, detailed planning of the manufacturing process. In order to realize a solution that is tailored to the needs of the customer, the operations of the company and all requirements and boundary conditions are investigated. As all disciplines relating to bonding technology are concentrated at IFAM, the manufacturing technology business field can call on the expert know-how of the individual specialized areas throughout the realization and integration phases. All detailed matters are evaluated in close contact with the respective specialized work groups at IFAM. The manufacturing technology business field plays a central mediating role in this process. This interdisciplinary approach ultimately guarantees optimum integration of bonding technology into a production process – a service that only a research and development institute of IFAM's standing and scope can provide.

Production planning

Production planning involves detailed investigation of how the adhesive can best be applied to components. The aim is an optimum production process with very low rejection rates. The thorough planning of the work evaluates a number of alternatives and pinpoints the most practical solution, with constant consideration being made to both technical and economic aspects. This approach considerably reduces the phase leading to a final decision on investment.

Once the production boundary conditions are known, then the optimum combination of application techniques, machinery, dosing equipment, robots and other parameters must subsequently

Examples of IFAM's areas of work:

(top) Atmospheric pressure plasma unit
The nozzle assemblies are configured for simultaneous activation of several separate treatment tracks.

(bottom) Thermal analysis.

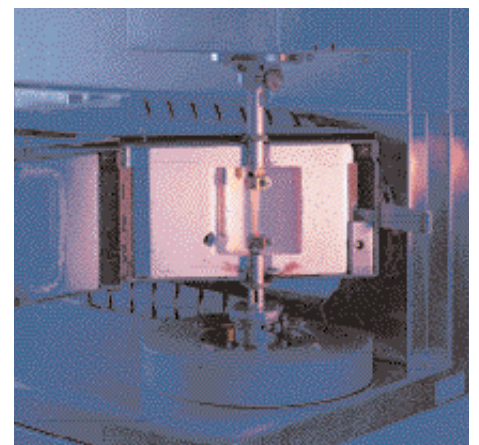
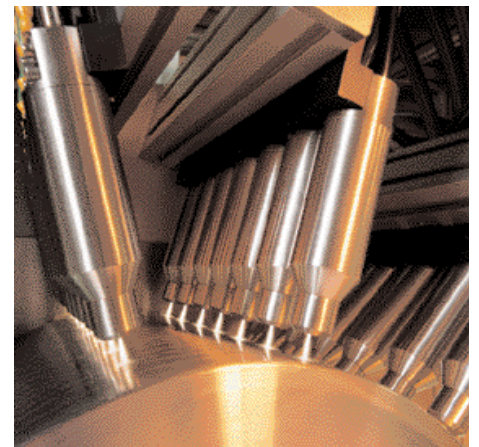

←
The new pilot-plant area

Proposals that are technically and economically viable

Contact person Production planning

Dipl.-Ing. Stephan Kim
Telephone: +49 (0) 421/22 46-5 25
E-mail kim@ifam.fraunhofer.de

be determined. For designing the workplace, IFAM uses amongst other things computer-aided 3D simulation tools, for which additional modules with user-specific functions have been developed. Here, detailed bonding-specific parameters have been taken into account for the robot simulation in order to obtain even more realistic results. Instead of costly experimental rigs this allows different lower cost scenarios to be tested. The use of robots, the movement of components, cycle-time changes, accessibility and collision risks are thoroughly investigated and assessed. Potential fault sources can hence be recognized at a very early stage, so avoiding later start-up costs and costs for modifications.

Once the planning process is complete, the proposed solution is discussed with the customer. All proposals assess the economic aspects of the various alternatives in addition to technical considerations. For economic evaluation of the application of bonding technology, IFAM has developed a computer-based system of performance figures that visualizes the effects of various decisions in production planning.

During the ultimate integration of the solution chosen by the customer, the first control code for the real application can be obtained from the simulation model. Here, parameters such as the speed of the TCP, product quantity, cycle-time, spatial aspects and the mode of operation of the dosing equipment can already be taken into account.

The »digital factory« is becoming more commonplace: initial simulation of manufacturing processes by computer is becoming ever more standard in manufacturing industries. Changes to the construction schedule can thus be planned and calculated in advance. This considerably shortens the time up to actual implementation. The Manufacturing technology business field at IFAM also utilises this approach in order to provide customers with an optimum service.

Flexible planning in the IFAM pilot-plant for automated adhesive processing using 3-D simulation systems.

(top) Layout planning and motion simulation with subsequent off-line programming of the industrial robot.

(bottom) TSI dosing unit for flexible processing of 2-component adhesives from cartridges, hobbocks, or drums.

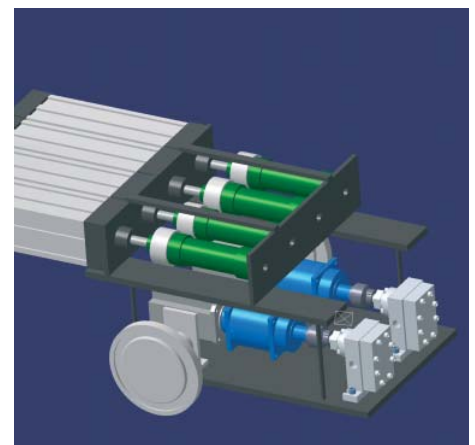
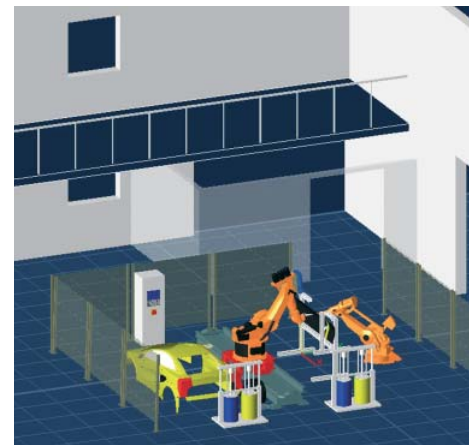

Ideal implementation – from experiment to series production

Contact person
Integration into production

Dipl.-Ing. Manfred Peschka
Telephone: +49 (0) 421/22 46-5 24
E-mail pe@ifam.fraunhofer.de

Optimum design of bonding processes is the basis for trouble-free production. Industrial production systems with robots, dosing equipment and peripherals mean high investment costs. There are many reports about plants being disassembled unused because they did not meet requirements. The expert know-how of the manufacturing technology business field prevents such expensive failed investments.

(right) Precision dosing unit for automatic application of 2-component adhesives from twin cartridges – developed by IFAM.

Integration into production

The central aspect of integration into production is optimum conceptualization and design of the bonding equipment. Even for dosing equipment alone there are many different individual components. Selecting these components requires consideration of the particular processing properties of the respective adhesives and the quantities to be applied. The manufacturing technology business field develops reliable production processes and in the first instance investigates the effectiveness of these processes using statistical methods. This approach guarantees customers a production unit that functions in practice. The independence of IFAM as a research and development institute means that an optimum result is produced that is not distorted by commercial interests.

The Fraunhofer IFAM has a state-of-the-art small pilot-plant where the simulations are tested in practice. The constant adaption of simulation and integration allows different variants to be tested and improved. For this the manufacturing technology business field possesses an extremely flexible system, which is unique in Europe for its degree of modularity. Feed systems, pipe systems, dosing equipment and application equipment can be freely combined with each other and adapted to the relevant requirements – hitherto an unknown approach. As a consequence, the final result totally meets the desires of the customer.

Other services of the manufacturing technology business field include project leadership for introducing bonding solutions, coordination of deliveries, monitoring interfaces and constant scientific-technical supervision of the production process.

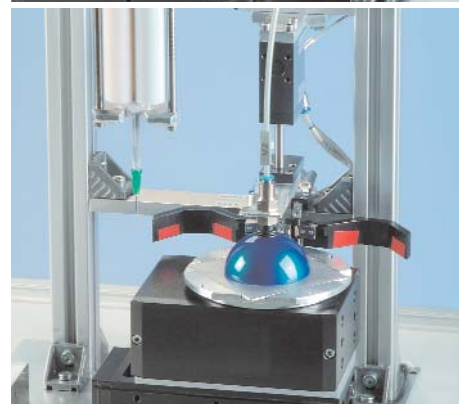
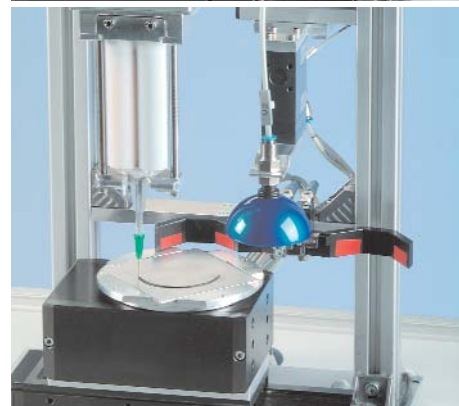
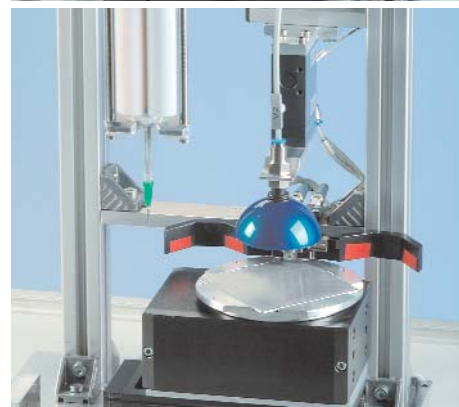
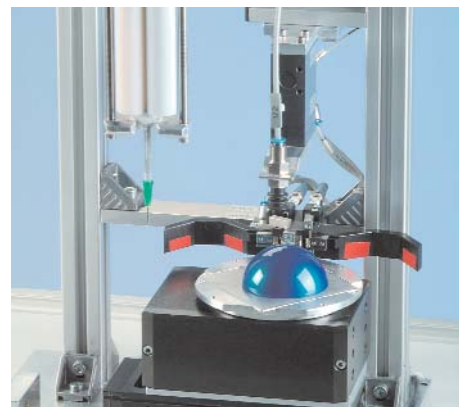

Further information is available on the
business fields:

- Adhesive Bonding Technology
- Surfaces.

IFAM
Fraunhofer-Institute
for Manufacturing Technology and
Applied Materials Research
– Adhesive Bonding Technology and Surfaces –

Institute director:
Prof. Dr. Otto-Diedrich Hennemann
Wiener Straße 12
D-28359 Bremen

Telephone: +49 (0) 421/22 46-0
Fax: +49 (0) 421/22 46-4 30
E-mail ktinfo@ifam.fraunhofer.de

Manufacturing technology
Head:
Dipl.-Ing. Manfred Peschka
Telephone: +49 (0) 421/22 46-5 24
E-mail pe@ifam.fraunhofer.de

Further information:
www.ifam.fraunhofer.de